

LEARNING MATERIALS

SEMESTER : 6TH SEMESTER

BRANCH : MECHANICAL ENGINEERING

SUBJECT : INDUSTRIAL ENGINEERING

&

MANAGEMENT

(TH-1)

FACULTIES : (1) ER. SUBODHAKANTA GARNAIK (LECT. IN MECH. ENGG.)
(2) ER. HIMANSU SEKHAR SAMAL (LECT. IN MECH. ENGG.)



PURNA CHANDRA INSTITUTE OF ENGINEERING & TECHNOLOGY

AT/P.O.-CHHENDIPADA, DIST.-ANGUL.

CHAPTER – 1

Q. What is plant & plant layout ?(S-2016)

Ans: Plant layout refers to the physical arrangement of production facilities. It is the configuration of departments, work centres and equipment in the conversion process.

According to Moore "Plant layout is a plan of an optimum arrangement of facilities including personnel, operating equipment, storage space, material handling equipment and all other supporting services along with the design of best structure to contain all these facilities".

The overall objective of plant layout is to design a physical arrangement that meets the required output quality and quantity most economically

Q. Selecting the plant site in a city (Urban site) 2016(s)(New)

Ans:Advantages

1. A city is very well connected by rail, road and air.
2. It provides a good market also.
3. Right labour force is available
4. Power and water is easily available.
5. It has good hospitals, marketing centers, schools, banks, recreation clubs, etc.
6. The factory can be set up in an existing available building.
7. Workers and foremen's training classes and many other educational facilities can be found in cities.

Disadvantages:

1. Land available for the building is limited in area.
2. Cost of land and building construction is high.
3. Expansion of the industry is seldom possible.
4. Local taxes etc., are high
5. Labour salaries are high
6. Union problems are more; employee-employer relations are not so good.

Q. Objectives of plant layout(S-2016)2019

Ans:The primary goal of the plant layout is to maximize the profit by arrangement of all the plant facilities to the best advantage of total manufacturing of the product.

Thus the objective of plant planning is the best relationship between output, space and manufacturing cost.

The objectives of plant layout are :

1. Streamline the flow of materials through the plant.
2. Facilitate the manufacturing process.
3. Maintain high turnover of in process inventory.
4. Minimize materials handling.
5. Effective utilization of men. Equipment and space
6. Make effective utilization of cubic space.
7. Flexibility of manufacturing operations and arrangements.
8. Provide for employee convenience, safety and comfort.

Q. Factors Influencing plant Layout (S-2016)

1. Type of production – Engineering industry, process industry
2. Production system – job shop, batch production, mass production.
3. Scale of production.
4. Availability of the total area.
5. Arrangement of material handling system.
6. Type of building – single storey or multi storey

Q. Symptoms of Bad Layout(S-2016)2019

- Ans:**
1. Long material flow lines and backtracking (re handling)
 2. Poor utilization of space.
 3. Congestion for movement of materials and men.
 4. Large amount of work – in- process
 5. Long production cycles.
 6. Excessive handling of materials.
 7. More frequent accidents.
 8. Difficult to supervise and control.

CHAPTER : 2

Q. A furniture manufacturer makes two products X_1 and X_2 namely Chairs and Tables. Each chair contributes a profit of Rs. 20 and each table that of Rs. 40. Chairs and Tables, from raw material to finished product, are processed in three sections S_1, S_2, S_3 . In section S_1 each chair (X_1) requires one hour and each table (X_2) requires 4 hours of processing. In section S_2 , each chair requires 3 hours and each table one hour and in section S_3 the times are 1 and 1 hour respectively. The manufacturer wants to optimize his profits if sections S_1, S_2 and S_3 can be availed for not more than 24, 21 and 8 hours respectively.

Ans: The first step is to formulate the linear programming model, i.e. a mathematical model from the data given above. The model is as under :

Maximize $Z = \text{Rs. } 20 X_1 + \text{Rs. } 40 X_2 \dots\dots\dots(Z)$

Subject to $X_1 + 4X_2 \leq 24 \dots\dots\dots(C_1)$

$3X_1 + X_2 \leq 21 \dots\dots\dots(C_2)$

$X_1 + X_2 \leq 8 \dots\dots\dots(C_3)$

$X_1, X_2 \geq 0 \dots\dots\dots(C_4)$

C_1 is constraint No. 1 and so on.

The second step is to convert the constraint inequalities temporarily, into equations, i.e.

$X_1 + 4X_2 = 24 \dots\dots\dots (C_1)$

$3X_1 + X_2 = 21 \dots\dots\dots (C_2)$

$X_1 + X_2 = 8 \dots\dots\dots (C_3)$

In third step axis are marked on the graph paper and are labeled with variables X_1 and X_2 .

Fourth step is to draw straight lines on the graph paper using the constraint equations, and to mark the feasible solution on the graph paper. For example, taking first constraint equation.

$X_1 + 4X_2 = 24$

Substitute $X_1 = 0$, then $X_2 = 24/4 = 6$

Next, Substitute $X_2 = 0$, then $X_1 = 24$

OPERATIONS RESEARCH:

Mark the point of 24 at X_1 axis and point of 6 on X_2 axis. Join them. This straight line represents C_1 equation. Similarly constraint equations C_2 and C_3 can be plotted.

According to constraint C_4 , X_1 and X_2 are greater than (or equal to) zero, hence the marked area (region) between $X_1 = X_2 = 0$ and C_1, C_2, C_3 represents the feasible solution

As the fifth step, a (dotted) straight line representing the equation (Z) is drawn, assuming any suitable value of Z say 120.

In the sixth step, a straight line Z_m is drawn parallel to the line Z , at the farthest point of the region of feasible solution, i.e., point B, at the intersection of C_1 and C_3 . The co-ordinates of point B can be found by solving equations C_1 and C_3 .

$$X_1 + 4X_2 = 24$$

$$X_1 + X_2 = 8$$

Subtracting $3X_2 = 16$, therefore $X_2 = 16/3$ and $X_1 = 8/3$

These values of X_1 and X_2 can also be read from the graph itself. Thus the maximum value of Z is

$$Z_m = 20 X_1 + 40 X_2 = 20 \times (8/3) + 40 \times (16/3) = 800/3 = 266.6$$

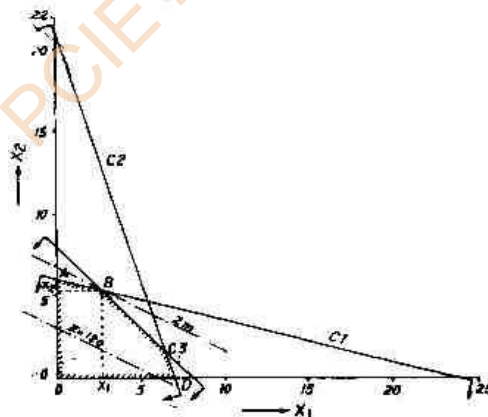

Fig. 11.2. Graphical method.

Q. Linear Programming:-

Ans: Linear programming is a powerful mathematical technique which allocates scarce- available under condition of certainty in an optimum manner to achieve company objective which may be maximum overall profit and minimum investment.

Q. At what places a linear programming can be effectively used ?

- Ans:**
- i) Where objectives are stated mathematically.
 - ii) Resources are measured in quantities.
 - iii. The variables of problem bear a linear (straight line) relationship.
 - iv. There are too many solutions to be evaluated.

Maximise

$$Z = 2x + 3y$$

$$X + 2y = 1 \dots\dots\dots C_1$$

$$2x + y = 4 \dots\dots\dots C_2$$

$$X \leq 0$$

$$Y \leq 0$$

Q. Step Involved in LPP (Linear Programming Problem)

- 1. The first step is to formulate a linear programming model or mathematical model from given data.
- 2. The second step is to be convert in equality constraint temporarily in to equation.
- 3. In third step axes are marked on the graph paper and labeled with variables.
- 4. In fourth step straight lines are drawn using constraint equations and feasible solution is marked.
- 5. In fifth step a dotted straight line representing equation of Z is drawn assuming a suitable value.
- 6. In six step a straight line (Z_m) is drawn parallel to Z at the farthest point of region of feasible solution.

FORMATION OF LPP

A furniture manufacturer makes two products X_1 and X_2 namely chairs and tables each chair contributes a profit of Rs. 20 and each table Rs 40 chairs and table from raw material to finished product are process in three sections. S_1, S_2, S_3 . In section S_1 each chair requires one hour and each table requires four hours of processing. In section S_2 each require 3 hours and each table requires 1 hour.

PROCESS LAYOUT

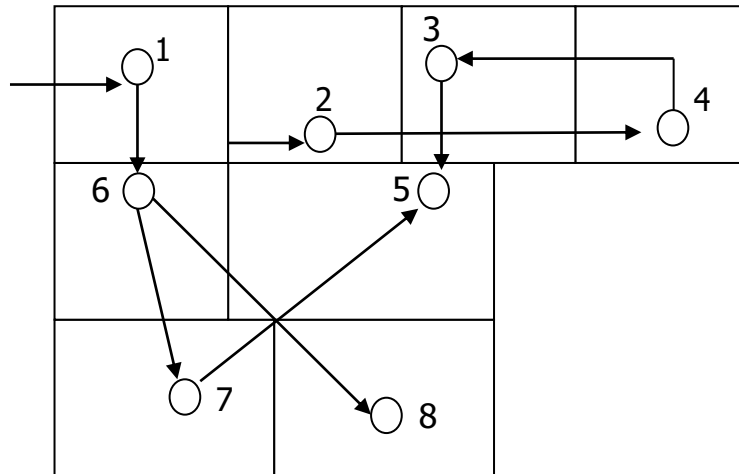

Process Layout showing product movement

PRODUCT LAYOUT

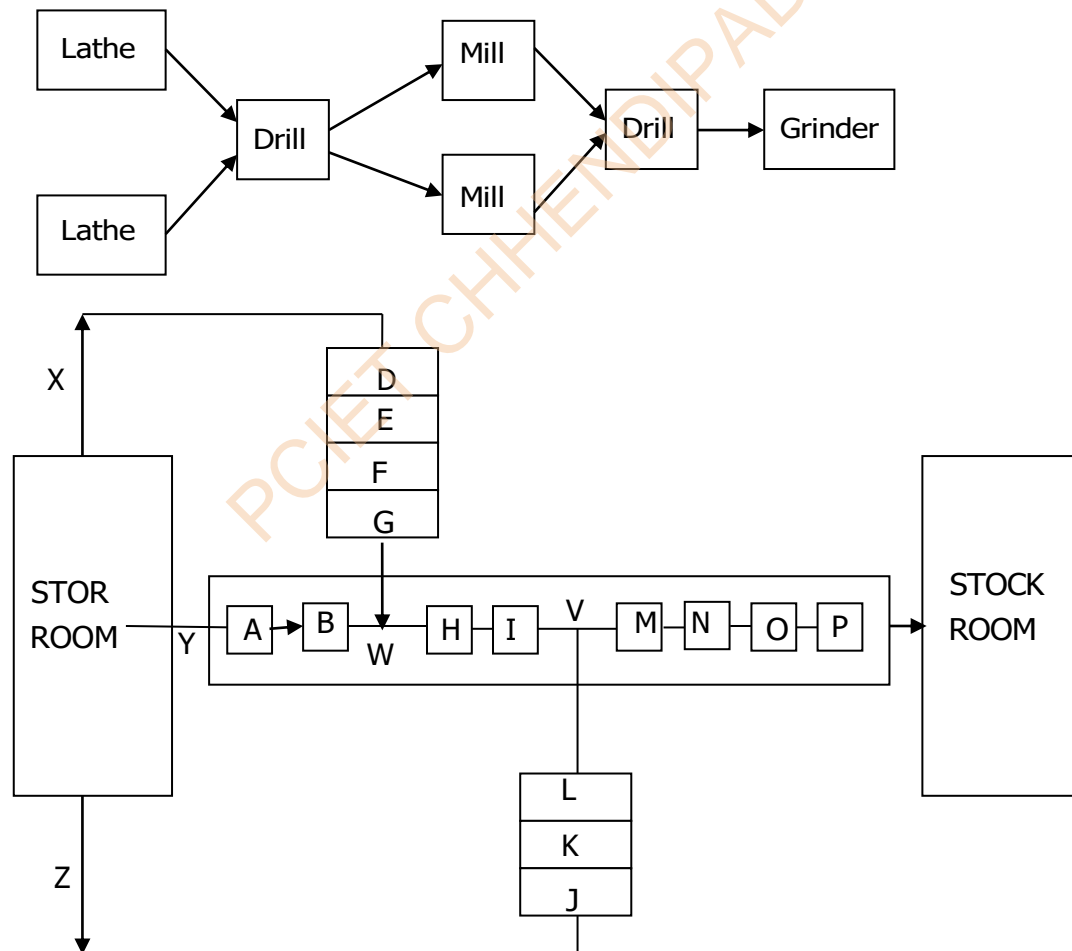

Raw materials from store is fed a long three line X, Y, Z. The materials in X line get processed on machine & D, E, F & G and meet the material of Y

line being on machines A and B meet at W. The product of X line & Y line get process on machines H and I. Then material of Z line after being process on machines L, K & J meet the product of X line & Y line at V. The assembly of product of X line, Y line & Z line are processed on machines M, N, O, P & goes to stock room.

Advantages :-

- i) less space requirement for same volume of production.
- ii) less in process inventory
- iii) Smooth U continuous work law.
- iv) Less skilled workers are requirement.
- v) Automatic material handling is possible.

Disadvantages:-

- i) Any change in the product involves a major change in the layout which is trouble same.
- ii) Since machines are scattered in a line in product layout so more no. of machines have to be purchase keeping a few stand by. It increase the capital investment cost.
- iii) In product layout inspection becomes difficult because one inspector in has to look after machines in two or more production lies.

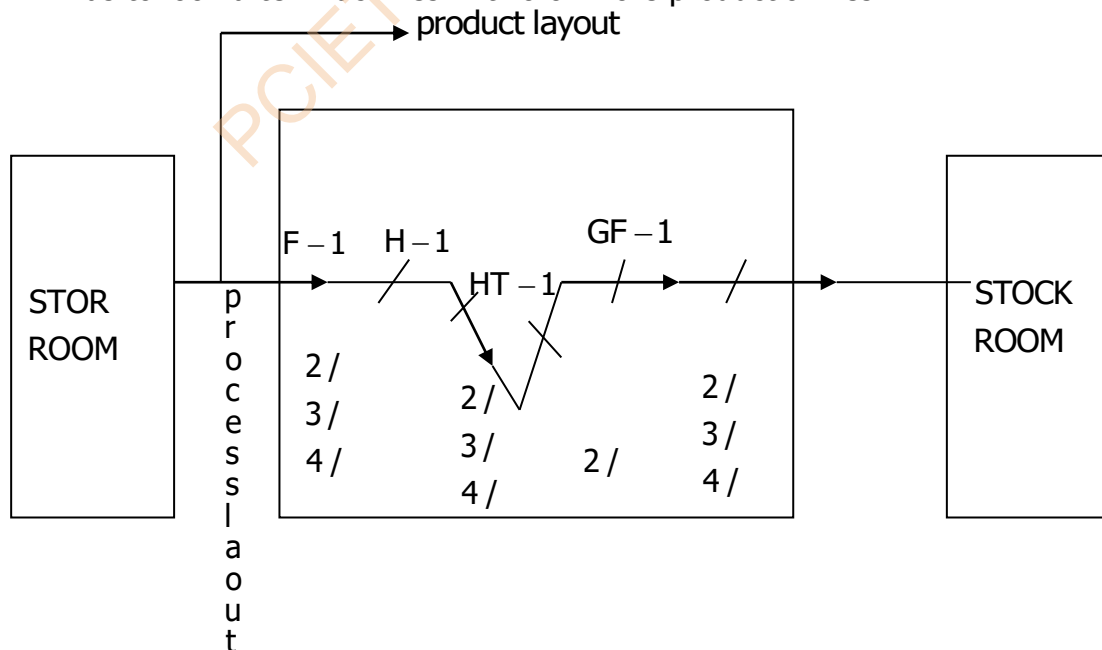

F = Flank forging

H = Hobbing machine for cutting gear teeth

HT = Heat treatment furnace

GF = Gear finishing machine

Theory:-

- It is a combination of both product layout and process layout generally the use of either product layout or process layout rare.
- In that case combination layout is preferable in this type of layout items of different types and different sizes are manufacture. So, different machines are arranged in sequences to manufacture to different type and sizes of product this type of layout is frequently use in actual practice.

Q. DEFINE OPERATION RESEARCH WITH ITS APPLICATION & METHODS (S-2016)

DEFINATION:- It is the organized application of modern science, mathematics and computer technique to complex (difficult) military, government and industrial problem arising in the direction of management of large system of men, material money and machinery.

APPLICATION OF OPERATION RESEARCH:-

- i) Location of factories and warehouses to minimize transportation cost,
- ii) Work allocation to machines to minimize production time and cost.
- iii) Establishing equitable bonus system.
- iv) Petrochemical mixes.
- v) Material handling.
- vi) Municipal and hospital Administration
- vii) Routing of tankers.

METHODS OF OPERATION RESEARCH (O.R)

Following types of O.R. (operation research) are used to solve problems of optimization. (maximization)

Linear programming.

- a) Graphical linear programming

Transportation method:

- i) Vogel Approximate method
- ii) Northwest method

Q. A small engineering project consists of 6 activities namely A, B, C, D, E and F with duration of 4, 6, 5, 4, 3 and 3 days respectively. Draw the network diagram and calculate EST, LST, EFT, LFT and floats. Mark the critical path and find total project duration.(S-2016)

Ans:

(1) EST is calculated by starting from event-1, i.e. activity A and giving it a time 0 (EST). Now EST of activity B = 0 + duration of activity A = 4
 EST of activity C = EST of activity B + duration of activity B = 4 + 6 = 10 and so on.

EST of activity F can be found by following two paths, i.e. 1-2-3-5 and 1-2-4-3. The path 1-2-3-5 gives 15th day whereas the path 1-2-4-3 estimates 11th day as EST of activity F

Table

Activity	Duration (days)	EST	LST	EFT	LFT	Total Float	Free Float	Independent Float
A	4	0	0	4	4	0	0	0
B	6	4	4	10	10	0	0	0
C	5	10	10	15	15	0	0	0
D	4	4	8	8	12	4	0	0
E	3	8	12	11	15	4	4	0
F	3	15	15	18	18	0	0	0

COL.1	COL.2	COL.3 from N.W. diagram	COL.4 LFT -D	COL.5 EFT +D	COL.6 from N.W. diagram	COL.7 LST - EST or LFT - EFT
-------	-------	----------------------------------	--------------------	--------------------	----------------------------------	---------------------------------------

Naturally the bigger value (15) is selected because until activity C is completed which ought to finish on 15th day, activity F cannot be started.

EST for other activities is calculated by proceeding similarly, in the forward direction from the first event to the last event.

(2) LFT is calculated in a similar manner as EST but by proceeding backward from the last event to

NETWORK ANALYSIS

The first one. For example

LFT for activity F = 18

LFT for activity C and E = 18 – duration of activity F = 15

LFT for activity D = LFT for activity E-duration of activity E. = 15-3=12 and so on.

(3) LST for each activity is calculated from the relation.

LST = LFT of an activity – duration of that activity

For example, LST of activity D = 12 – 4 = 8

(4) EFT for each activity is calculated from the relation.

EFT = EST of an activity + duration of that activity

For example, EFT of activity D = 4 + 4 = 8.

(5) Total float = (LST-EST) or (LFT-EFT)

For example, total float for activity

D = (8-4) or (12-8) = 4

(6) Free float = EST of tail event – EST of head event – activity duration.

For example, free float for activity D (fig).

= 8 – 4 – 4 = 0

(7) Independent float = EST of tail event – LFT of head event activity duration.

For example, Independent float for activity D.

8 – 4 – 4 = 0

(8) Critical path is one which consumes maximum time and it is 1-2-3-5-6.

The total project duration, therefore, is :

4 + 6 + 5 + 3 = 18 days.

Q. Difference between PERT and CPM.(S-2016)

Ans: The fundamental network of PERT and CPM are though identical, yet there are (certain) difference in details as mentioned below:

PERT	CPM
<ol style="list-style-type: none">1. A probabilistic model with uncertainty in activity duration . Expected time is calculate from t_o, t_m and t_p.2. An event-oriented approach3. PERT terminology uses words like network diagram, events and slack.4. The use of dummy activities is required for representing the proper sequencing.5. PERT basically does not demarcate between critical and non-critical activities.6. PERT finds applications in projects where resources (men, materials and specially money) are always made available as and when required.7. Especially suitable in defence projects and R & D where activity times cannot be reliably predicted.	<ol style="list-style-type: none">1. A deterministic model with well-known activity (single) times based upon past experience. It assumes that the expected time is actually the time taken.2. An activity-oriented system.3. CPM terminology employs words like arrow diagram, nodes, and float.4. The use of dummy activities is not necessary. The arrow diagram thus becomes slightly simpler5. CPM marks critical activities.6. CPM is employed to those projects where minimum overall costs is of primary importance. There is better utilization of resources.7. Suitable for problems in industrial setting, plant maintenance, civil construction projects etc.

CHAPTER:3

Q. Calculate EOQ & cycle time of the given datas ?(S-2016)

- i) Annual usage, $U = 60$ units
- ii) Procurement cost, $P = \text{Rs. } 15$ per order
- iii) Cost per piece, $C = \text{Rs. } 100$
- iv) Cost carrying inventory I , a percentage including expenditure on obsolescence, taxes insurance deterioration etc. = 10 % . Calculate E.O.Q.

$$Q = \sqrt{\frac{2U.P.}{C.I}}; \text{ substituting the values}$$

$$Q = \sqrt{\frac{2 \times 60 \times 15}{100 \times (10/100)}} = 13.41$$

$$\text{Therefore, number of order per year} = \frac{60}{13.41} = 4.47 \text{ say } 5.$$

$$\text{Hence } Q \text{ or E.O.Q.} = \frac{60}{5} = 12 \text{ units}$$

Cycle time=

Q. MEANING OF INVENTORY(S-2016)

Ans: Inventory generally refers to the materials in stock. It is also called the idle resource of an enterprise. Inventories represent those items which are either stocked for sale or they are in the process of manufacturing or they are in the form of materials which are yet to be utilized.

Q. INVENTORY CONTROL:-

Ans: Inventory control is a planned approach of determining what to order, when to order and how much to order and how much to stock so that costs associated with buying and storing are optimal without interrupting production and sales. Inventory control basically deals with two problems. (i) When should an order be place ? (Order level), and (ii) How much should be ordered ? (Order quantity)

Q. OBJECTIVES OF INVENTORY CONTROL (S-2016)

Ans: 1. The ensure adequate supply of products to customer and avoid shortages as far as possible.

2. To make sure that the financial investment inventories is minimum (i.e., to see that the working capital is blocked to the minimum possible extent).
3. Efficient purchasing, storing, consumption and accounting for materials is an important objective.
4. To maintain timely record of inventories of all the items and to maintain the stock within the desired limits.
5. To ensure timely action for replenishment.
6. To provide a reserve stock for variations in lead times of delivery of materials.
7. To provide a scientific base for both short-term and long-term planning of materials.

Q. BENEFITS OF INVENTORY CONTROL:-(S-2016)

Ans:It is an established fact the through the practice of scientific inventory control, the stocks can be reduced anywhere between 10 percent to 40 percent. The benefits of inventory control are :

1. Improvement in customer's relationship because of the timely delivery of goods and services.
2. Smooth and uninterrupted production and, hence no stock out.
3. Efficient utilization of working capital.
4. Helps in minimizing loss due to deterioration, obsolescence damage and pilferage .
5. Economy in purchasing.

Q. ABC analysis(S-2016)

The inventory of an industrial organization generally consists of consos of items with varying prices usage rate and lead time. It is neither desirable nor possible to pay equal attention to all the items. For example, a T.V. set has about 5 per cent of its parts contribute to 80 per cent of the total costs. This is true of majority of the items like car, refrigerator, etc.

ABC analysis is a basic analytical tool which enables management to concentrate its efforts where results will be greater.

The Pareto principle (20/80) of cause and effect is useful concept in business where it can be used to solve majority of production, quality and inventory problems.

The concept applied to inventory control is called as ABC analysis.

Statistics reveal that just a few items account for bulk of the annual consumption of the materials. These few items are called A class items which hold the key to business. The other items known as B and C which are numerous in number but their contribution is less significant. ABC analysis thus tends to segregate the items into three categories A, B and C on the basis of their annual usage. The categorization is made to pay right attention and control demanded by items.

A class items : These items hardly constitute 5-10 per cent of the total items and account for and need to be stocked in smaller quantities. These items are to be procured frequently and each time less quantity is procured. The inventory of A class items is kept at minimum.

B class items: These items are generally 10-15 per cent of total items and represent 10-15 per cent of the total expenditure on materials. These are intermediate items. The control on these items should be intermediate between A and C items.

C class items : These are about 70-80 per cent in number and constitute on 5-10 per cent total expenditure on materials.

These items being less expensive does not require strict control. These are ordered in bulk as against infrequent ordering of A class items.

Advantages of ABC Analysis(S-2016)

This approach helps the manager to exercise selective control and focus his attention only on a few times.

By exercising strict control of A class items, the materials manages is able to show the results within a short period of time. It results in reduced clerical costs, saves time and effort and results in better planning and control and increased inventory turnover. ABC analysis, thus tries to focus and direct the effort based on the merit of the items and thus becomes an effective management control tool.

Procedure for making ABC analysis:-

1. Calculate the total inventory value for each item held in inventory by multiplying the number of units used in a year by its unit price.
2. Tabulate these items in descending order of their values placing first the item having the highest total value and so on.
3. Prepare a table showing item No., unit cost, annual units consumed and annual rupee value of units used.
4. Compute the running total item by item for the items and also for rupee value of consumption.

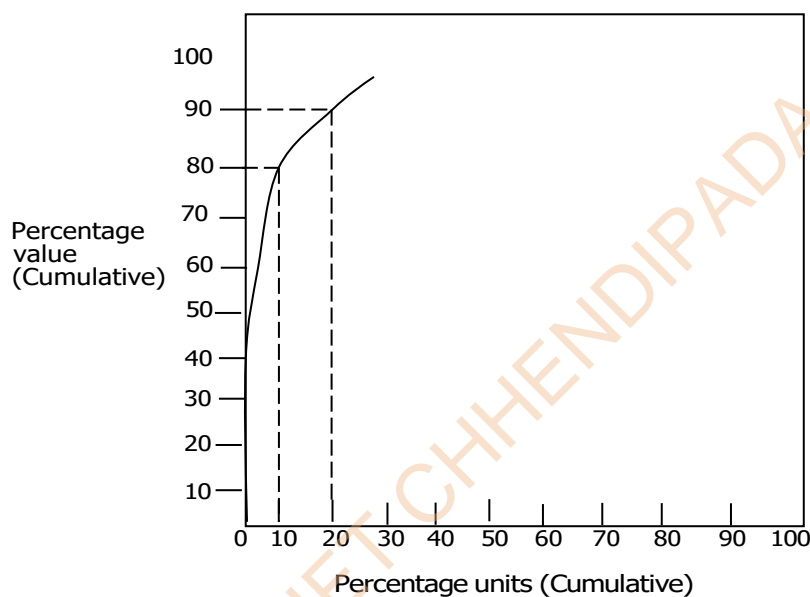

5. Compute the cumulative percentage for the item count and cumulative annual usage value.
6. Classify the items as per the norms for ABC items.
7. The cumulative percentage are represented graphically as in fig.

CHAPTER:6

Q. Write three objectives of plant maintenance(S-2016)

1. Machines and other facilities should, be kept in such a condition which permits them to be used as their optimum (profit making) capacity without any interruption or hindrance.
2. The objective of plant maintenance is to achieve minimum breakdown and to keep the plant in good working condition at the lowest possible cost.
3. Maintenance division of the factory ensures the availability of the machines, buildings and services required by other sections of the factory for the performance of their functions at optimum return on investment whether this investment be in material, machinery or personnel.

Q. Duties functions and responsibilities of plant maintenance engineering department (S-2016)

Ans:i. Depending upon the size of the maintenance department, it has a wide variety of duties of functions to perform.

The work is under the control of plant engineer or maintenance engineer who normally reports to the works manager.

- ii. The different duties, functions and responsibilities of the maintenance department are as follows:

(A) Inspection:-

1. Inspection is concerned with the routine schedule checks of the plant facilities to examine their condition and to check for needed repairs.
2. Inspections ensure the safe and efficient operation of equipment and machinery.
3. Frequency of inspections depends upon the intensity of the use of the equipment. For example belts in a machine may be checked every week; furnace equipment every month; an over-head bridge crane every four months and so on.
4. Inspection section makes certain that every working equipment receives proper attention.

5. Items removed during maintenance and overhaul operations are inspected to determine the feasibility of repairs.
6. Maintenance items received from vendors are inspected for their fitness.

(B) Engineering:

1. Engineering involves alterations and improvements in existing equipments and building to minimize breakdowns.
2. Maintenance department also undertakes engineering and supervision of constructional projects that will eventually become part of the plant.
3. Engineering and consulting services to production supervision are also the responsibilities of maintenance department.

(C) Maintenance (Including preventive maintenance):-

1. Maintenance of existing plant equipment.
2. Maintenance of existing plant buildings and other service facilities such as yards, central stores roadways, sewers, etc.
3. Engineering and execution of planned maintenance, minor installations of equipment, building and replacements.
4. Preventive maintenance, i.e. preventing breakdown (before it occurs) by well conceived plans of inspection, lubrication, adjustments, repair and overhaul.

(D) Repair:-

1. Maintenance department carries out corrective repairs to alleviate unsatisfactory conditions found during preventive maintenance inspection.
2. Such a repair is an unscheduled work often of an emergency nature, and is necessary to correct breakdown and it includes trouble calls.

(E) Overhaul

1. Overhaul is a planned, scheduled reconditioning of plant facilities such as machinery, etc.
2. Overhaul involves replacement, reconditioning, reassembly etc.

(F) Constructions:

1. In some organizations, maintenance department is provided with equipment and personnel and it takes up construction jobs also.
2. Maintenance department handles construction of wood, brick and steel structures, cement and asphalt paving, electrical installations. Etc.

(G) Salvage:-

1. Maintenance department may also handle disposition of scrap or surplus materials. This function involves
 - Segregation, reclamation and disposition of production scrap, and
 - The collection and disposition of surplus equipments, materials and supplies.

(H) Clerical Jobs:-

1. Maintenance department keeps records
 - of costs,
 - of time progress on jobs
 - Pertaining to important features of buildings and production equipments; electrical installations; water, steam, air and oil lines; transportation facilities (such as elevators, conveyors, powered trucks, cranes, etc)

(I) Generation and distribution of power and other utilities.

(J) Administration and supervision of labour force (of maintenance department)

(K) Providing plant protection, including fire protection.

(L) Insurance administration.

(M) Establishing and maintaining a suitable store of maintenance materials.

(N) Janitorial service.

(O) House keeping.

Good housekeeping involves upkeep and cleaning of equipments, building, toilets, wash – rooms, etc.

(P) Pollution and noise abatement.

CHAPTER:7

Q. Define inspection, quality & control (S-2016)

It means checking the accessibility of a manufacturing product. It measures the quality of product in terms of predetermined standard. Quality control is a step of testing and analysis of a product which concludes whether the product is as per laid standard or not. Quality is that which customer wants.

Q. KINDS OF INSPECTION :- (S-2016)

- Ans:**
- Roving, process, patrolling or floor inspection,
 - Fixed inspection,
 - Key-point inspection, and
 - Final inspection

(a) Roving Inspection:

The inspector walks round on the shop floor from machine to machine and checks samples of the work of various machine operators or workers.

INSPECTION AND QUALITY CONTROL

FLOOR INSPECTION:

- helps catching errors during process itself, i.e. before the final production is ready
- It is more effective and desirable because the work need not be transported to a centralized (inspection) place.

(b) Fixed Inspection:

- The work is brought at intervals for inspectors to check
- Fixed inspection discovers defects after the job has been completed.
- Fixed inspection is used when inspection equipments and tools cannot be brought on the shop floor.
- It is a sort of centralized inspection, the worker and the inspector do not come in contact with each other; thus it eliminates any chances of passing a doubtful product.

(c) Key Inspection:-

- Every product (more or less) has a key point in its process of manufacture.

- A key point is a stage beyond which either the product requires an expensive operation or it may not be capable of rework.
- Inspection at a key point segregates and thus avoids unnecessary further expenditure on poor and substandard parts, which are likely to be rejected finally.

(d) Final Inspection:-

- The final inspection of the product may check its appearance and performance.
- Many destructive and non-destructive inspection and test methods such as tensile, fatigue, impact testing etc, and ultrasonic inspection, X-ray radiography, etc, respectively, are available for final inspection of the products manufactured.
- Final inspection is a centralized inspection and it makes use of special equipments.

Q. Purposes or objectives of Inspection (S-2016)

- i. Inspection separates defective components from non-defective ones and thus ensures the adequate quality of products.
- ii. Inspection locates defects in raw materials and flaws in processes which otherwise cause problems at the final stage. For example, detecting the parts not having proper tolerance during processing itself, will minimize the troubles arising at the time of assembly.
- iii. Inspection prevents further work being done on semi-finished products already detected as spoiled.
- iv. Inspection makes sure that the product works and its works and it works without hurting anybody, i.e. its operation is safe.
- v. Inspection detects sources of weakness and trouble in the finished products and thus checks the work of designers.
- vi. Inspection builds up the reputation of the concern as it helps reducing the number of complaints from the customers.

Q. What is types of plant maintenance 2008 (s), 2007(w)

- Ans:**
- i. Scheduled Maintenance
 - ii. Preventive maintenance
 - iii. Predictive maintenance
 - iv. Break down maintenance

Scheduled:

- It is a stitch in time procedure
- It aims avoiding.
- Breakdown can be dangerous to life so it should be minimize by proper inspection, lubrication, repair and overhaul inspection of various equipments.
- It also involves cleaning of water tanks and white washing of building.

Break down:-

In this type of maintenance repairs are made after the equipment is out of order example of this type of maintenance are clearly given by :

- When an electric motor does not start a belt is broken.
- This type of maintenance is seriously taken up by production departmental the maintenance department to correct the defect.
- The maintenance dept. checks the difficulty and makes necessary.

Preventive:

It is system of plant, scheduled maintenance which tries to minimize breakdown, this type of maintenance locates weak spots which are under excessive vibration in equipment and provides them regular inspection and minor repairs by doing so, the danger of unanticipated breakdown can be reduce.

Predictive:-

It is a newer maintenance technique and makes use of human senses or other sensitive instrument like audio gauges vibration analyzer, amplitude meters pressure, temp and resistances to predict about trouble before the equipment fails simple hand touch their also predict about trouble equipment so that the equipment we require necessary repairs before being use.

In predicts maintenance the equipments are inspected periodically to avoid breakdown

Q. Control Charts –Purpose and Advantages:(S-2016)

- Ans:**
1. A control chart indicates whether the process is in control or out of control.
 2. It determines process variability and detects unusual variations taking place in a process.
 3. It ensures product quality level.
 4. It warns in time, and if the process is rectified at that time, scrap or percentage rejection can be reduced.
 5. It provides information about the selection of process and setting of tolerance limits.
 6. Control charts build up the reputation of the organization through customer’s satisfaction.

Types of Control Charts

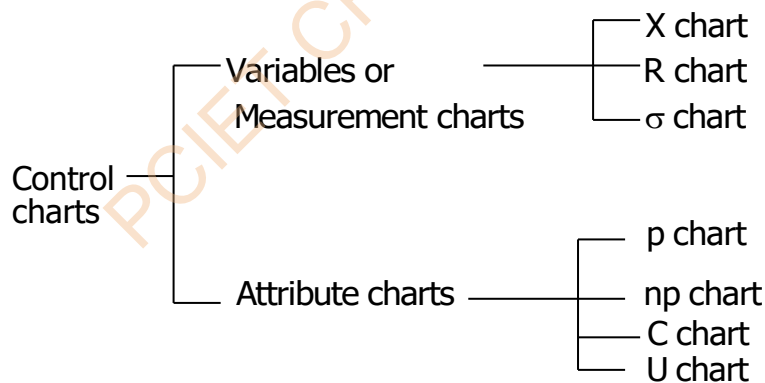

p-Charts

1. It can be a fraction defective chart or % defective chart (100p)
2. Each item is classified as good (non-defective) or bad (defective)
3. This chart is used to control the general quality of the component parts and it checks if the fluctuations in product quality (level) are due to chance cause alone.

4. It can be used even if sample size is variable (i.e., different for all samples). But calculating control limits for each sample is rather cumbersome.

p-Chart is plotted by calculating, first, the fraction defective and then the control limits. The process is said to be in control if fraction defective values fall within the control limits. In case the process is out of control an investigation to hunt for the cause becomes necessary

PCIET CHHENDIPADA

CHAPTER:8

Q. What are the characteristics of ISO-9000 (S-2016)

- 1. Meeting customers requirements.**
- 2. Be usable by all sizes of organizations**

Q. What are the stages of implementation of TQM(S-2016)

Ans:Stages of Implementation of TQM

The process of implementing TAM in an organization an be organized in the following four stages.

(i) Identification and preparation:

This stage is concerned with identifying and collecting information about the organization in the prime areas where improvement will have most impact on the organisation's performance and preparing the detailed basic work for the improvement of the organisation's activities. It is also important to find out the ost of quality, which incorporates the total cost of waste, error correction failure appraisal and prevention in the organization. It is also required to understand the views and opinions of the customers, suppliers the managers and the employees. The differences between their views and opinions will provide an idea of the scale of the problem and task ahead. The measurements of the cost of quality made at the beginning of the TQM process can be compared with measurement at a later stage to establish the achieved improvements. The initial measurements of the costs will also indicate the potential areas for improvement and direct efforts towards the areas where they are most needed. All data and information must therefore be identified, prepared and summarized in a manner to ensure that the managers get the correct information to make their decision.

(ii) Management Understanding:

This step is concerned with making sure that the management understands the objective and methodology of TQM and is ready to adopt them all the time. For many companies, TQM means a major change in the management practice and it is difficult to implement over a short period time.

However, to make a significant change in management practice, it is necessary to educate the managers in their understanding and approach to TQM. Once they have mastered the principle and practice of TQM the managers can then demonstrate their total commitment and take the lead in the quality improvement process.

(iii) Scheme for Improvement:

This state is concerned with identifying quality issues and affects a resolution of them by management led improvement activities. To develop quality improvement scheme, it is necessary to identify the quality problems in each division, in each department and throughout the whole organization. A scheme of training for improvement can be established after the realization of the following aspects of the organization. They are :

- Purpose of the department
- Customers and suppliers relationship
- Meeting customer needs
- Problem causes and best solutions
- Prevention of recurring problems
- Customer satisfaction
- Priorities for improving efficiency

At this stage it is essential to know that any scheme for improvement requires substantial investment in training, management time and communication.

(iv) Critical Analysis:

This stage starts with new targets and take the complete improvement process to everybody indicating supplier and customer links in the quality chain. It also obtains information about progress and consolidates success. To focus quality aspects, everybody in the organisation must assess the TQM process. It is essential to incorporate the perception of both internal and external customers. It is also important to ensure that everybody in the organisation gets some feedback of the success on a regular basis and at the same time the individual and team contributions are given the recognition. Setting up of new targets as required by customers at this stage will automatically upgrade the

quality standard of the organisation and maintain the competitive position in the market place.

List of Techniques for TQM

1. Customer's perception surveys
2. Quality function deployment
3. Cost of quality statement
4. Top team workshops
5. Total quality seminars
6. Departmental purpose analysis.
7. Quality training
8. Improvement action team
9. Quality circles
10. Suggestion schemes
11. Help calls
12. Visible data
13. Process management
14. Statistical process analysis
15. Process capability analysis
16. Fool proofing
17. Just in Time manufacturing (JIT)
18. Business Process Reengineering (BPR)
19. Quality Improvement Team (QIT)

TQM Model:

Customer satisfaction is the focus of TQM. The model shown in fig. highlights how the implementation of TQM benefits the company in both long term and short term and in turn achieves the customer satisfaction.

Basically, the customer satisfaction depends upon the gap between the expected and actual quality of products offered to the customer. When the customer's expectations of product/service quality balance the actual product quality offered by the company, the customer satisfaction results. If the customer's expectations exceed the actual results in customer delight. TQM aims

at customer delight going one step ahead of mere satisfaction of customers. The delighted customer will become the loyal customer and have a complete trust in the offering of the company's products and services. The quality of the product results in higher reliability of which in turn helps to attain the retention of loyal customer base.

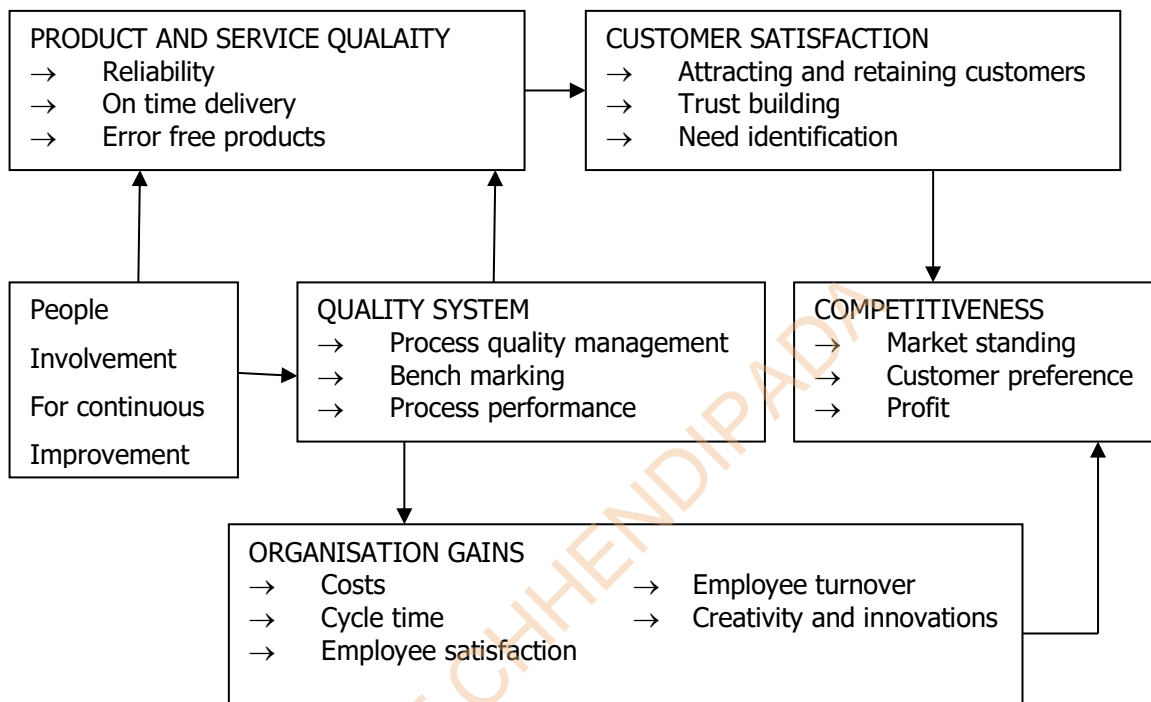

Q. Explain JIT technique (S-2016)

Just in time (JIT) is a production strategy striving to improve a business return on investment by reducing in-process inventory and associated carrying costs. To meet JIT objectives, the process relies on signals or Kanban between different points in the process. Kanban are usually "tickets" but can be simple visual signals, like the presence or absence of a part on a shelf. Implemented correctly, JIT focuses on continuous improvement and can improve a manufacturing organization's return on investment, quality and efficiency. To achieve continuous improvement, key areas of focus are:

1. Flow
2. Employee involvement
3. Quality.

Noticing that stock depletion requires personnel to order new stock is critical to the inventory reduction at the center of JIT. But JIT relies on other elements in the inventory chain. Therefore, JIT is best implemented as one part of an overall lean manufacturing system.

Benefits of JIT:

- Reduced setup time. Cutting setup time allows the company to reduce or eliminate inventory for "changeover" time.
- The flow of goods from warehouse to shelves improves. Small or individual lot sizes reduce lot delay inventories, which simplifies inventory flow and its management.
- Employees with multiple skills are used more efficiently. Having employees trained to work on different parts of the process allows companies to move workers where they are needed.
- Production scheduling and work hour consistency are synchronized with demand. If there is no demand for a product at the time, it is not made. This saves the company money, either by not having to pay workers overtime or by having them focus on other work.
- Increased emphasis on supplier relationships. A company without inventory does not want a supply system problem that creates a part shortage. This makes supplier relationships extremely important.
- Supplies come in at regular intervals throughout the production day. Supply is synchronized with production demand and the optimal amount of inventory is on hand at any time. When parts move directly from the truck to the point of assembly, the need for storage facilities is reduced.
- Minimizes storage space needed.
- Smaller chance of inventory breaking/expiring.

Q What is time study ?

Time study is a structured process of directly observing and measuring human work using a timing device to establish the time required for completion of the work by a qualified worker when working at a defined level of performance.

Q/Describe different types of over heads ?

Types of Overheads

There are three main types of overhead that businesses incur. The overhead expenses vary depending on the nature of the business and the industry it operates in.

1. Fixed overheads

Fixed overheads are costs that remain constant every month and do not change with changes in business activity levels. Examples of fixed overheads include salaries, rent, property taxes, depreciation of assets, and government licenses.

2. Variable overheads

Variable overheads are expenses that vary with business activity levels, and they can increase or decrease with different levels of business activity. During high levels of business activity, the expenses will increase, but with reduced business activities, the overheads will substantially decline or even be eliminated.

Examples of variable overheads include shipping costs, office supplies, advertising and marketing costs, consultancy service charges, legal expenses, as well as maintenance and repair of equipment.

3. Semi-variable overheads

Semi-variable overheads possess some of the characteristics of both fixed and variable costs. A business may incur such costs at any time, even though the exact cost will fluctuate depending on the business activity level. A semi-variable overhead may come with a base rate that the company must pay at any activity level, plus a variable cost that is determined by the level of usage.

Examples of semi-variable overheads include sales commissions, vehicle usage, and some utilities such as power and water costs that have a fixed charge plus an additional cost based on the usage.

Q/ Factors affecting quality of manufacture ?

1. Money:

Most important factor affecting the quality of a product is the money involved in the production itself. In the present day of tough and cut throat competition, companies are forced to invest a lot in maintaining the quality of products.

2. Materials:

To turn out a high quality product, the raw materials involved in production process must be of high quality.

3. Management:

Quality control and maintenance programmes should have the support from top management. If the management is quality conscious rather than merely quantity conscious, organisation can maintain adequate quality of products.

4. People:

People employed in production, in designing the products must have knowledge and experience in their respective areas.

5. Market:

Market for the product must exist before quality of the product is emphasized by management. It is useless to talk about the quality when the market for the product is lacking. For example, there is no demand for woolen garments in the hot climates (e.g., Southern part of India).

6. Machines and Methods:

To maintain high standards of quality, companies are investing in new machines and following new procedures and methods these days.

Q/what is prime cost ?

Prime costs are a firm's **expenses** directly related to the materials and labor used in production.

Q/ Features governing plant location?

main factors that affect a plant location are as follows:2019

- Law and order situation,
- Availability of infrastructure facilities,
- Good industrial relations,
- Availability of skilled workforce,
- Social infrastructure,
- Investor friendly attitude,
- Nearness to market,
- Nearness to raw-materials' source

PCIET CHHENDIPADA